

KEY FEATURES

- Power Module for PCB Mountable
- High Efficiency up to 91%
- 4:1 Wide Input Range
- Low Ripple and Noise
- Remote ON/OFF Control
- Operating Temperature: -40°C...+80°C (with derating)
- Very Small Size :2.01 x 1.0 x 0.47 Inches
- Screw Terminal for Option
- Safety Meet UL / IEC / EN 62368-1 & 60950
- 3-Years Product Warranty



ELECTRICAL SPECIFICATIONS

All specifications valid at normal input voltage, full load and +25°C after warm-up time unless otherwise stated.

Model No.	with Heatsink	ST50F-24-5S X ST50F-48-5S X	ST50F-24-12S X ST50F-48-12S X	ST50F-24-15S X ST50F-48-15S X	ST50F-24-24S X ST50F-48-24S X
Model No.	without Heatsink	ST50F-24-5S ST50F-48-5S	ST50F-24-12S ST50F-48-12S	ST50F-24-15S ST50F-48-15S	ST50F-24-24S ST50F-48-24S
Max Output Wattage	(W)	50 W			
Input	Voltage (V.DC.)	ST50F-24-xS X, ST50F-24-xS: 24V (9-36V)			
		ST50F-48-xS X, ST50F-48-xS: 48V (18-75V)			
Output	Voltage (V.DC.)	5V	12V	15V	24V
	Trim Voltage Range	±10%			
	Voltage Accuracy	±2%			
	Current (mA) max	10000	4167	3333	2083
	Line Regulation (LL-HL) (typ.)	±0.5%			
	Load Regulation (10-100%) (typ.)	±1%			
	Capacitor Load (max.)	12,000uF	2,000uF	1,200uF	400uF
	Ripple & Noise (typ.)	(Note 1) 100mV	150mV	1% of Vout	1% of Vout
	Efficiency	90%	91%	90%	91%
Protection	Over Power Protection	Auto-recovery / Latch			
	Over Voltage Protection	Zener diode clamp			
	Over Temperature Protection	Auto-recovery			
	Short Circuit Protection	Auto-recovery / Latch			
Isolation	Voltage	2250 VDC (60 seconds)			
	Resistance	10 ⁸ ohms			
	Capacitance	1500 pF			
Environment	Operating Temperature	(Note 2) -40°C...+80°C (with derating)			
	Storage Temperature	-45°C...+100°C			
	Case Temperature	+110°C max.			
	Temperature Coefficient	±0.05%/°C			
	Humidity	95% RH			
	MTBF	>550,000 h @ 25°C (MIL-HDBK-217F)			
Physical	Dimensions (L x W x H)	2.01 x 1.0 x 0.47 Inches (51.0 x 25.5 x 12.0 mm) Tolerance ±0.5 mm			
	Case Material	Six-side shielded Aluminum with Conductive base, Black Anodize			
	Weight	ST50F-x-xS X : 58 g (with Heatsink) ST50F-x-xS : 40 g (without Heatsink)			
	Cooling Method	Free-air convection			
Remote ON/OFF	DC-DC ON	When ON/OFF CTL and -DC IN is Open			
	DC-DC OFF	When ON/OFF CTL and -DC IN is Short			
EMC	EMI (Conducted & Radiated Emission)	(Note 3) EN 55032 class A			
	EMS (Noise Immunity)	EN 55035			

NOTE

1. Ripple & Noise are measured at 20MHz of bandwidth with ceramic 0.1uF & chemi-con KY 47uF parallel capacitor.

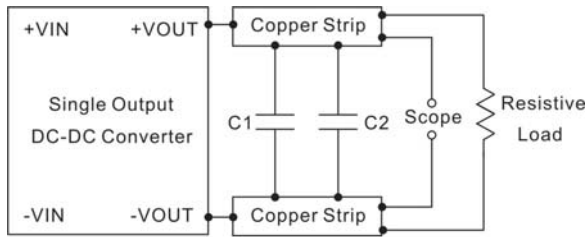

C1=0.1u~1uF
C2=47u~100uF

Use a Cout ceramic capacitor. Please refer to capacitor value of every series. Scope measurement should be made by using a BNC socket, measurement bandwidth is 0-20 MHz. Position the load between 50 mm and 75 mm from the DC-DC Converter.

2. That "natural convection" is about 20LFM but is not equal to still air (0 LFM).
3. For EMI test, Please refer to below.
4. Please refer to our PDF file "DC-DC Application" on our website: www.archcorp.com.tw

DERATING

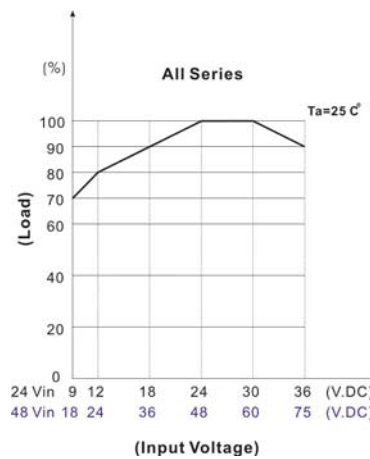
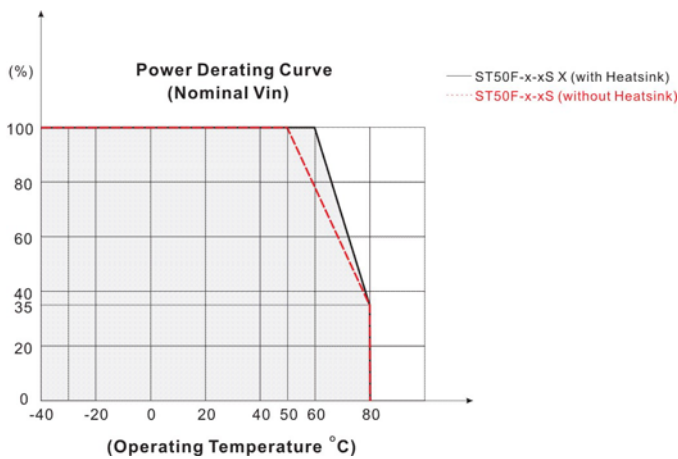

OUTPUT NOISE

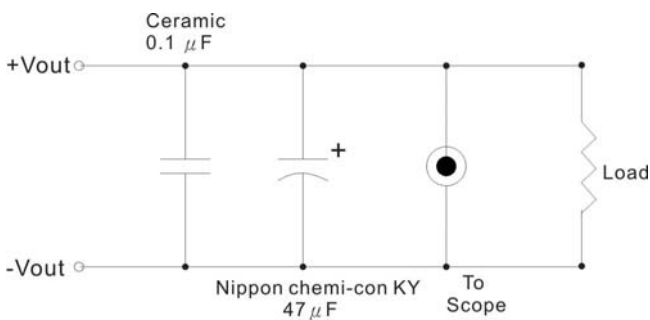

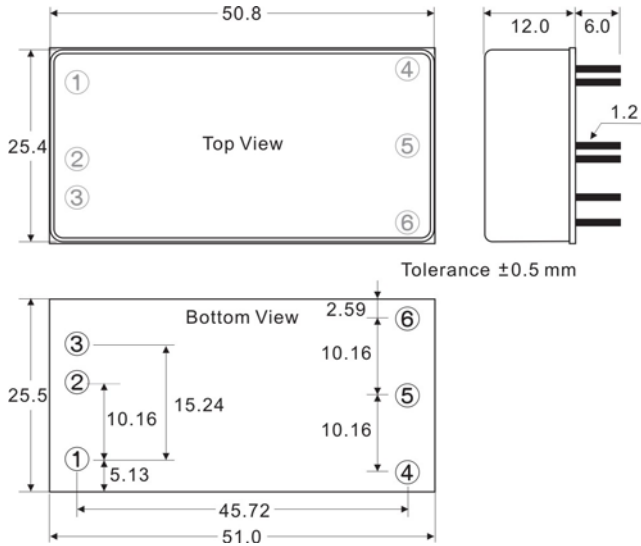
MECHANICAL DIMENSIONS
ST50F-x-xS (without Heatsink)

PIN#	Single
1	CTRL
2	-DC IN
3	+DC IN
4	TRIM
5	-DC OUT
6	+DC OUT

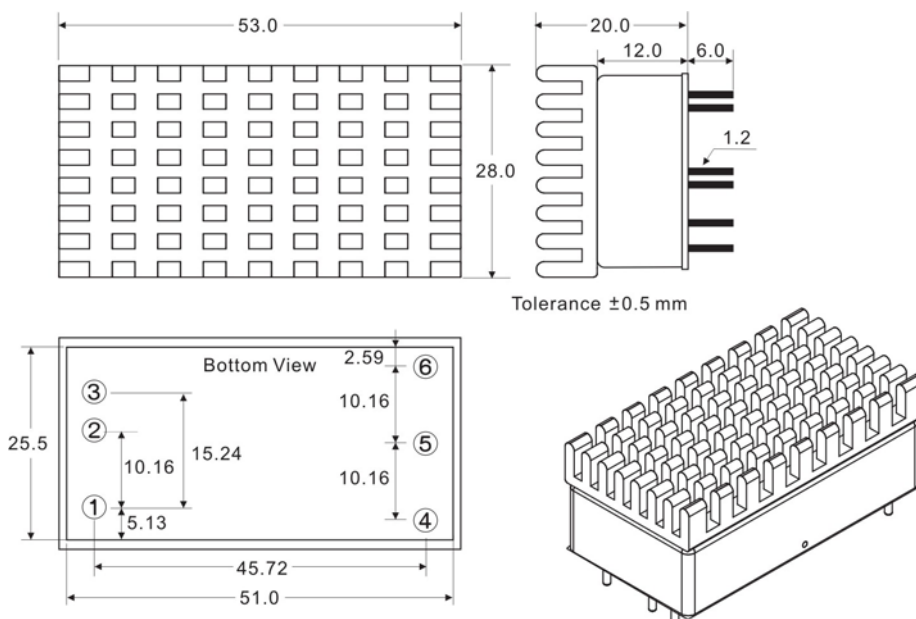
ST50F-x-xS X (with Heatsink)

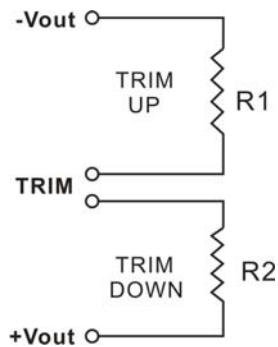
TRIM

	R1		R2	
5S	+10%	1%	-10%	-1%
	4.02K	~ 94K	0	~ 53K
12S	+10%	1%	-10%	-1%
	6.65K	~ 274K	68.1K	~ 953K
15S	+10%	1%	-10%	-1%
	6.19KK	~ 237KK	97.6K	~ 1.36M
24S	+10%	1%	-10%	-1%
	0	~ 272.6K	187K	~ 1.22M

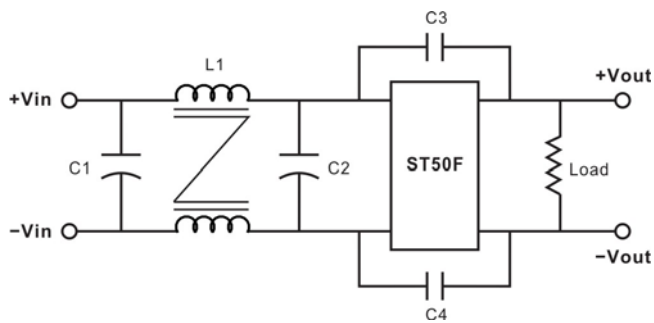
EMI

	L1	C1	C2	C3	C4
24-5S, 24-24S, 48-12S, 48-15S	3mH	220uF	220uF	1500pF	1500pF
24-12S, 24-15S, 48-5S, 48-24S	3mH	220uF	220uF	2200pF	2200pF

ST50F SERIES
50 Watts
SCREW TERMINAL
ST50F-A2

PIN#	Single
1	CTRL
2	-DC IN
3	+DC IN
4	TRIM
5	NO CONNECT
6	-DC OUT
7	NO CONNECT
8	+DC OUT

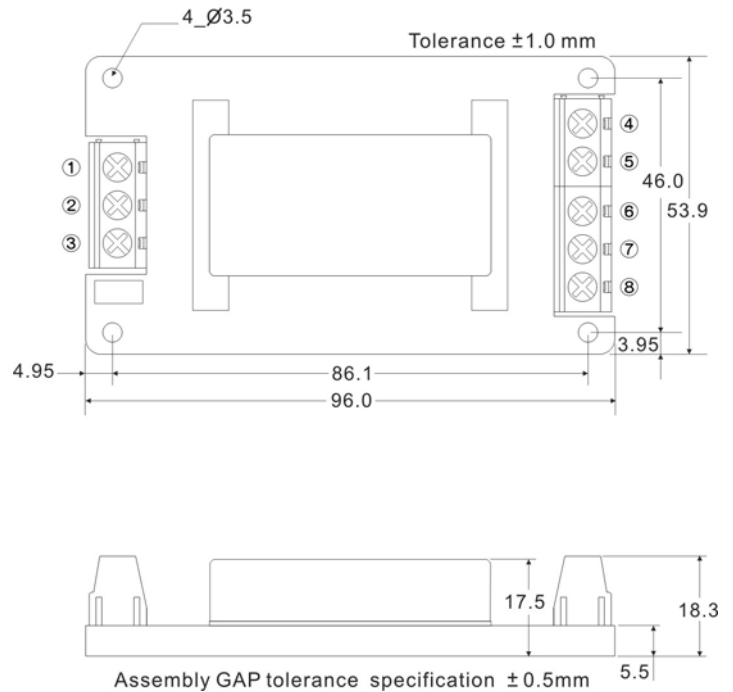
ST50F-A5

PIN#	Single
1	CTRL
2	-DC IN
3	+DC IN
4	TRIM
5	NO CONNECT
6	-DC OUT
7	NO CONNECT
8	+DC OUT

